

35682 KP-DB-I-MF-412

Metal distribution board

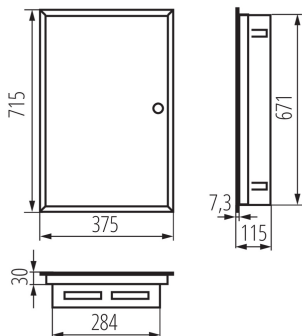

Metal Consumer Units with DIN rails for modular installation are manufactured at the Kanlux Factory. They are designed for public and office buildings. Their scope allows you to carry out installations also in areas such as extensive residential installations.

GENERAL DATA:

Colour: white

Door colour: white

Place of assembly: Recessed mount in the wall

Norm: PN-EN 62208

Length [mm]: 375

Width [mm]: 115

Height [mm]: 715

TECHNICAL DATA:

Rated voltage [V]: 230/400 AC

Rated frequency [Hz]: 50

Class of protection against electric shock : I

Material: steel

Number of modules: 4x12P

IP class: 30

number of rows: 4